

SURFACE MOUNTED

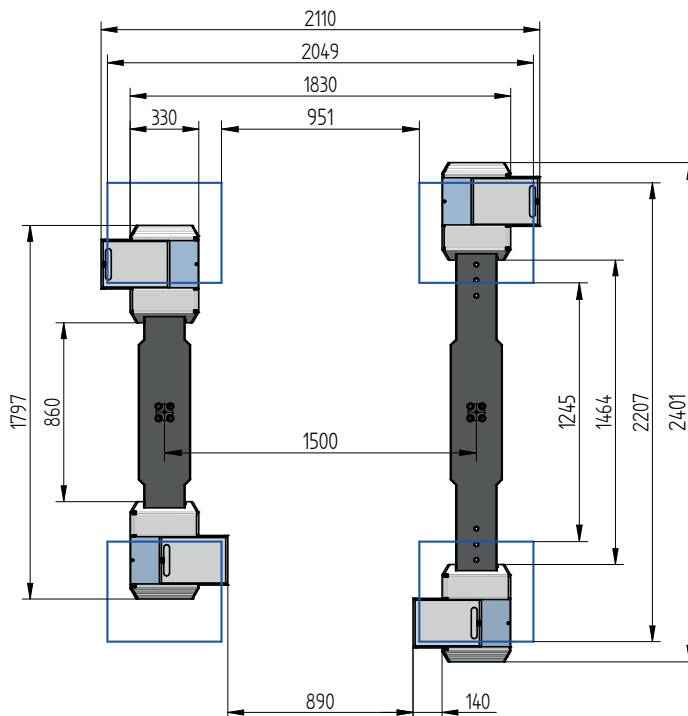
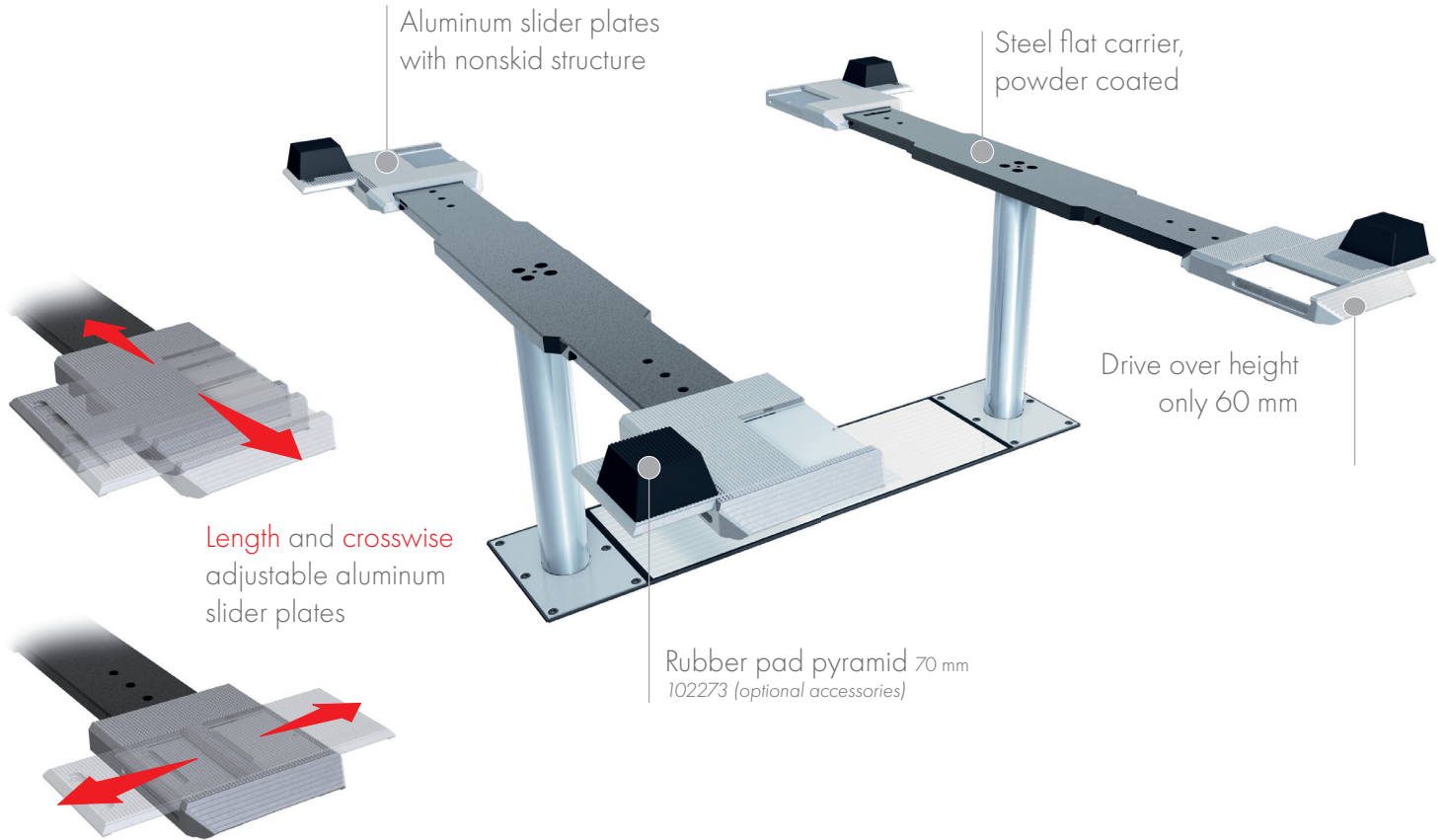

TECHNICAL DATA

Capacity	3500 kg
Effective raise height	2023 mm
Drive over height	60 mm
Piston diameter	123 mm
Piston distance	1500 mm
Installation depth	2408 mm
Motor output	3,0 kW
Power connector	400 V/16 A
Cable length to control	11 m
Lifting time	≈ 35 sec.
Lowering time	≈ 35 sec.

Support Uni 2.35 plus midi	102642
Support Uni 2.35 plus midi galvanized	105225
Installation cassette STEEL 1500 mm	2260XX
Installation cassette STEEL 1500 mm galvanized	2261XX
Lifting unit oil 3,5 t 1500 mm - K pre-assembled in installation cassette	109965
Lifting unit oil 3,5 t 1500 mm - H packed in wooden box	109977



ACCESSORIES

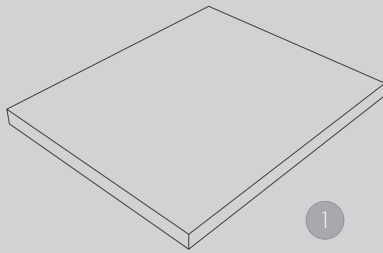

1

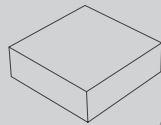

2

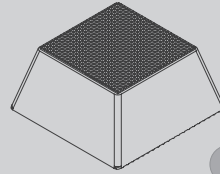

3

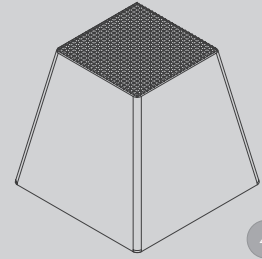

4

1 | Rubber pad
290 x 335 x 20 mm
102275 (1 Set / 4 Pieces)

2 | Rubber pad
120 x 120 x 40 mm
102274 (1 Set / 4 Pieces)

3 | Rubber pad pyramid
70 mm
102273 (1 Set / 4 Pieces)

4 | Rubber pad pyramid
140 mm
102291 (1 Set / 4 Pieces)

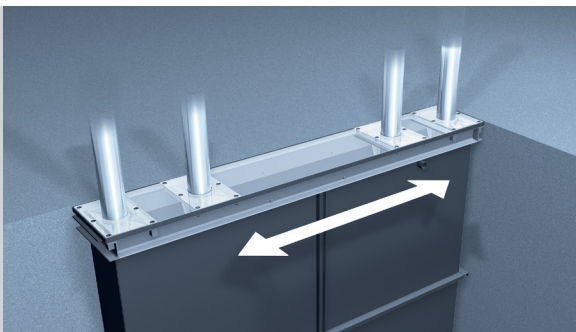

Future Proof Installation cassette

Stell 2530 mm
Drilling pattern 2530 / 2285 / 1785 / 1500

2530XX

Steel galvanized 2530 mm
Drilling pattern 2530 / 2285 / 1785 / 1500

2531XX

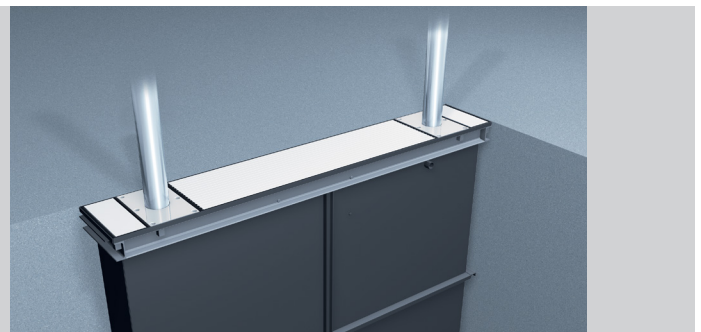

Cover kit for Future Proof Installation cassette

111582

Herrmann AG
Bahnhofstrasse 32
D-93483 Pöding

Phone: +49 (0)9461/91388 50
E-Mail: sales@herrmann-lifts.com

www.herrmann-lifts.com