



Snap-on Tools

"The Choice of Better Mechanics"



RONDO
www.rondodoo.hr

AKCIJA VRIJEDI DO 30.11.2018

ILI DO ISTEKA ZALIH

***cijene su bez PDV-a**

SNAP-ON TOOLS CORPORATION KENOSHA, WISCONSIN

LOG SUPPLEMENT "U-1"

091 275 0896 / dejan@rondodoo.hr

EFFECTIVE 8-29-55

★ ENHANCE YOUR KIT! ★



22-PC 3/8" Metric General Service Set XX1810-222AFSMP

- Set contains a Dual 80° Ratchet, a range of sockets, extensions and much more!

4.872,74
2.690,00

A GREAT STARTER SET!

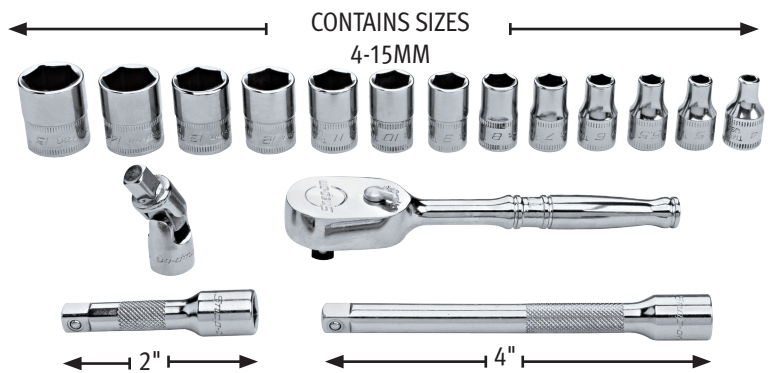

A GREAT STARTER SET!

17-PC 1/4" General Service Set XX1810-117TMM

- Set includes: high strength sealed ratchet, 13 shallow sockets, 2 extensions and universal joint

2.532,32
1.350,00

10-PC 3/8" 6pt Flare Nut Socket Set XX1810-210FRXM



CONTAINS SIZES 10-19MM

GREAT FOR TURBO AND FUEL LINES!
3410,88
2.300,00

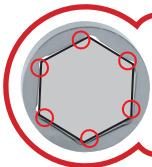

FLANK DRIVE®
Socket drives fasteners on the flats, therefore providing 15-20% more turning power and less chance of rounding

11-PC 1/4" & 3/8" Tamper Resistant Torx Plus® Socket Set XX1810-211EFTXRTPY



2.449,86
1.600,00

Set contains:

- 1/4" sizes - T8, T10, T15, T20 & T25
- 3/8" sizes - T27, T30, T40, T45, T50 & T55

GREAT FOR VARIOUS DELPHI AND JOHN DEERE DIESEL INJECTOR PUMPS!

7-PC 3/8" Torx® Bit Stubby Socket Set XX1810-207EFTXYSE

- Contains sizes: T27, T30, T40, T45, T47, T50 and T55



1.262,74
625,00

8-PC 1/4" & 3/8" Stubby Hex Socket Driver Set XX1810-208EFTAMXSY

- Contains sizes: 3-10mm



946,96
490,00

GREAT IN TIGHT SPACES!

3/8" Round Head Ratchet XX1810-FN100

- 100 tooth gear design provides minimal swing arc



734,16
430,00

GET THE RIGHT TOOLS!



**ROBUST DESIGN!
ALLOWS IMPACT USE IN
CONFINED AREAS!**



2-PC Impact Stud Extractor Set

XX1810-ITCSTUD-PK2

- 1/4" covers sizes 2 – 7mm
- 3/8" covers sizes 6 – 12.5mm

790,50
420,00

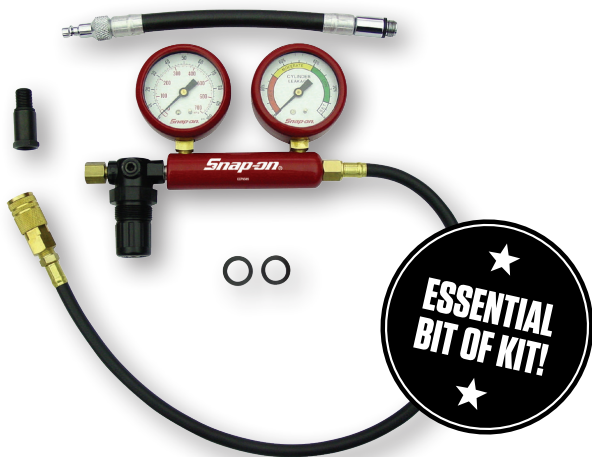

Cylinder Leakage Tester

XX1810-EEPV509

2.099,88
1.175,00

- Input pressure gauge displays input air pressure for proper cylinder leakage test set-up and accurate results
- Pressure gauge range is 0 - 6 bar

8-PC Impact Driver Set

XX1810-208EPIT

- Includes PIT120 Impact Driver, 1/4", 5/16", 3/8" Flat Tip Drivers, #2, #3, #4 Phillips® Drivers & #2 POZIDRIV®

**INCLUDES
STORAGE CASE!**

1.914,82
990,00



9-PC 3/8" Triple Square Driver Set

XX1810-BLPXZNM389

- Contains sizes: 4 – 18mm
- Satin chrome plated for corrosion resistance

463,22
320,00



**SHORT, COMPACT, ONE PIECE DESIGN
FOR IMPROVED ACCESSIBILITY AND
SUPERIOR STRENGTH!**

Right Angle Reversible Air Drill

XX1810-AT811

- Convenient, one-hand push button forward/reverse operation

1.695,18
990,00



i SPECIFICATION

Torque Output (Nm)	Up to 6
Free Speed (RPM)	1,320

PERFECT FOR WORKING IN COMPACT AREAS!

STOP! HAMMER TIME!

24oz Ball Peen Hammer

XX1810-HBBD24
XX1810-HBBD24G
XX1810-HBBD24O

657,02
390,00

- Polished steel peen and head for a smooth striking surface
- Composite shank extends from the head through the handle, delivering a more powerful blow and dampening vibration

AVAILABLE IN **RED, GREEN & ORANGE!**

GREAT FOR BRAKE DRUMS, TIE RODS, U-JOINTS AND MUCH MORE!

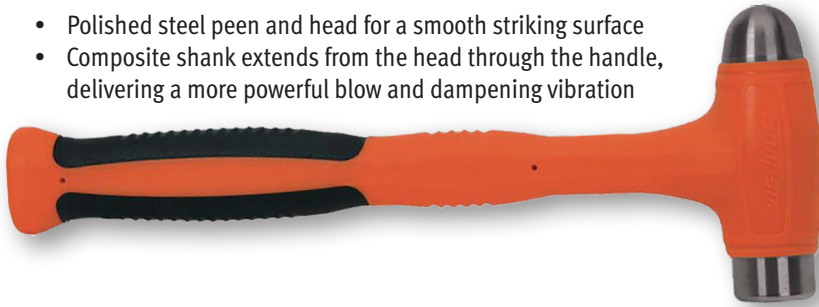

Dead Blow 32oz Dual Face Drilling Hammer

XX1810-HSSD32

782,42
490,00



Dead Blow 10oz Slimline Hammer

XX1810-HBSE10

279,68
210,00



4-PC Chisel Set

XX1810-CHSL400R
XX1810-CHSL400G
XX1810-CHSL400O

- Set includes: 1/4", 1/2", 3/4" & 1" chisels
- Blade has long edge taper and extra 10° in the tip which ensures proper sharpness

AVAILABLE IN **RED, GREEN & ORANGE!**

699,96
500,00



Slide Hammer Puller Set

XX1810-CJ1200

- Contains a 5kg, contour-formed slide hammer and a variety of attachments for body repair work
- Use on wings, sills, door panels, bonnet and boot panels



GREAT FOR REMOVING DENTS & BUMPS!

2.395,14
1.650,00

GET A HANDLE ON IT!



2-PC Line Clamp Set
XX1810-SHP2KT

**COVERS HOSES
FROM 3-57MM!**

- Use to pinch off flexible lines to prevent spills when disconnected

270,94
220,00



**GREAT FOR FLARING BRAKE
PIPES WITHOUT THE NEED
FOR REMOVAL!**

750,00
490,00

3/16" Imperial On Car Brake Flare Tool
XX1810-SRNBFT-316

- No pushing back ensures the flare form is correct everytime
- Will flare steel and copper tubing

14-PC Drain Plug Key Set
XX1810-ITC5142A

421,80
280,00

- Features triangle 10mm, female square, M16 spline, square 8 - 13.1mm & hex 8 - 17mm



2-PC Offset Aviation Snip Set
XX1810-AVSOS20

**CUTS UP TO 18
GAUGE MILD
STEEL!**

- Offset blades allow cut material to flow beneath your hand without curling
- Manoeuvrable for angle cutting or pattern configurations

559,36
420,00



Swivel Head Riveter
XX1810-HPS202



- Head swivels 360° to rivet at any angle

394,44
290,00

BRUSH IT REAL GOOD!

13 CM Stainless Steel Wire Brush
XX1810-WBSS5

131,48
99,00

5 CM Mini Stainless Steel Wire Brush
XX1810-WBSS2

37,62
25,00

5 CM Mini Brass Wire Brush
XX1810-WBBS2

37,62
25,00



USEFUL ADDITIONS!

Combo Hose Clamp Pliers

XX1810-HCP48ACF

- 3 position joint gives wider jaw spread
- Radial jaw serrations allow user to grip and adjust hose

274,36
190,00



Lineman's Pliers

XX1810-57AHLF

463,22
290,00

- Induction hardened head for extra strength and durability
- Gripper teeth behind the head can be useful crimping area

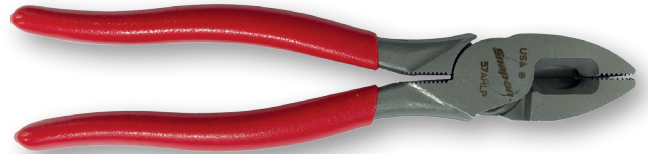

Trim Pad Removal Tools

XX1810-A181 - For Asia and Europe

279,68
160,00



XX1810-A177A - For US and Europe



289,68
160,00

XX1810-A161B - For US and Europe

279,68
160,00



Cordless Utility Light

CTLU761G
CTLU761O
CTLU761HV

- 4 hour run time with fast battery recharge
- Uses 14.4V Micro Lithium rechargeable battery

SUPER BRIGHT 540 LUMEN LIGHT OUTPUT!

AVAILABLE IN GREEN, ORANGE & HI-VIS!



650,18
490,00

*Battery and charger not included

SAFETY FIRST!

Amber Safety Glasses

XX1810-GLASS31BKA

139,00
99,00



Mirrored Safety Glasses

XX1810-GLASS31BKM

139,00
99,00

30" Pry Bar

XX1810-2430C

LONG LENGTH FOR GREATER LEVERAGE!

Pry bar has a tapered point on one end and a chisel type edge on the other for various applications

507,68
350,00



MAKING AN IMPACT!



12-PC 1/4" Deep Impact 6pt Socket Set
XX1810-112SMTMM

1.599,04
1.050,00

CONTAINS SIZES 5 - 15MM

7-PC 3/8" Low Profile Swivel Impact Socket Set
XX1810-207RIPFM

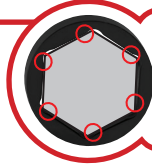

FLANK DRIVE®
Socket drives fasteners on the flats, therefore providing **15-20% more turning power** and less chance of rounding

DESIGNED FOR STRENGTH TO DELIVER A SOLID BLOW TO STUBBORN FASTENERS!

- Laser welded pivot pin allows smooth, full 30° swivel action for efficient power transfer

1.887,08
1.262,00



CONTAINS SIZES 10 - 18MM

7-PC 3/8" 6pt Semi-Deep Impact Socket Set
XX1810-207IMFMS

775,20
550,00



CONTAINS SIZES 10-18MM

3-PC 1/4" Impact Extension Set
XX1810-103ITMX



- Features snap ring anvil for excellent socket to extension engagement

394,44
255,00

3-PC 3/8" Lug Nut Socket Set
XX1810-203FLSM

- Set includes: 2 x Dual Flip sockets & 3" Impact Extension

638,40
420,00



INDUSTRIAL IMPACT!

8-PC 1/4" Shallow Impact Socket Set
XX1810-108IMTMM

748,22
420,00



CONTAINS SIZES 8-15MM

12-PC 1/2" Shallow Impact Socket Set
XX1810-312IMM

1.646,92
990,00



CONTAINS SIZES 15-25 & 27MM

SOCKETS THAT SHINE



CONTAINS SIZES 5.5-15MM

11-PC 1/4" Shallow Socket Set

XX1810-111TMUSMA

- Detent retaining system uses grooves on interior walls to ensure secure drive engagement

3.397,20
2.200,00

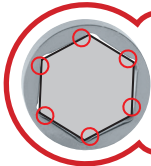

FLANK DRIVE®

Socket drives fasteners on the flats, therefore providing 15-20% more turning power and less chance of rounding

10-PC 1/2" Deep Socket Set

XX1810-310TSM

2.511,80
1.690,00



CONTAINS SIZES 10 & 12-20MM

6-PC 1/4" Torx® Standard Socket Set

XX1810-106TTX

- Set includes: 1/4" T8, T10, T15, T20, T25 & T27 standard torx bit sockets

1.266,16
890,00



7-PC 3/8" Low Profile Hex Socket Set

XX1810-207FHRM

- Set includes: 7, 8, 10, 12-14, 17mm

998,64
660,00



BUY THIS

7-PC 1/2" Hex Socket Set

XX1810-307ESAMYSF80

3.245,20
1.800,00



CONTAINS SIZES 6-19MM



GET THIS FREE!



1/2" Standard Flex-Head Ratchet

FLEX-HEAD FOR OPTIMUM ACCESS!

MORE HELPFUL TOOLS!



Memory Saver

XX1810-CTMS8850

A GREAT MEMORY AND TIME SAVER!

525,16
450,00

- For maintaining the vehicles electronic system settings when the battery is disconnected
- Connects using supplied OBDII diagnostic connector, battery lead connections or power adaptor
- Additional USB output is provided for recharging torches and other personal devices
- Powered by either 18V 7850/8850 lithium batteries (not supplied)

1/2" Soft Grip Extra Long Handle Ratchet

XX1810-SHLL80A
XX1810-SHLL80AO
XX1810-SHLL80AG



DUAL 80
TECHNOLOGY

- 80 TOOTH GEAR FOR SMOOTH RATCHETING
- 4.5° RATCHETING ARC - GREAT FOR TIGHT SPACES
- DUAL PAWLS MEAN 7 TEETH IN CONTACT WITH THE GEAR FOR STRENGTH AND DURABILITY



- Soft grip handle for optimum comfort

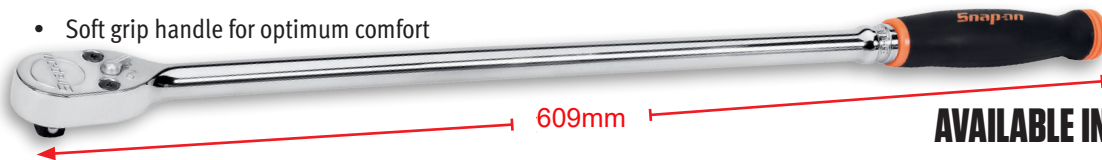

1.749,52
980,00

AVAILABLE IN GREEN & ORANGE!

36" Long 1/2" Breaker Bar

XX1810-SN36

HEAD DESIGN PUTS STRESS ON THE BAR RATHER THAN THE DRIVE!

1.307,20
720,00

- 36" overall length for increased leverage to break free stubborn fasteners



NEW PRODUCT!

9-PC Ball Hex Instinct® Screwdriver Set

XX1810-SGABM900BR
XX1810-SGABM900BG
XX1810-SGABM900BO

- Contains ball hex sizes 2-10mm
- Instinct® handle provides maximum turning power and greater comfort
- Ball hex allows up to 25° angle entry

EASIER AND MORE COMFORTABLE TO USE THAN HEX KEYS!

1.063,24
640,00

Applications include:

- Variable cam timing solenoids
- TPMS sensors
- Various motorcycle components

AVAILABLE IN RED, GREEN & ORANGE!



NEW!



12V Lithium Battery Booster

XX1810-EEJP200M

- For use on 4-8 cylinder cars, motorcycles and recreational vehicles
- Safer starting with reverse polarity protection, high temperature protection and short circuit protection
- Operating range: -20°C to 54°C
- Delivers 275 cranking amps

2.298,62
1.700,00

GREAT FOR PERSONAL USE AND EMERGENCY JUMPS, YET POWERFUL ENOUGH FOR THE SHOP!

RE-THREADING DEALS

14-PC Metric Tap and Die Set

XX1810-RTD15M

- Includes seven dies and seven taps

382,66
290,00



20-PC Master Spindle Rethreading Set

XX1810-RD20

- Covers imperial 3/4" - 27/32" and metric M16 - M27 sizes
- Dies are manufactured from high tempered steel for strength and durability

REPAIR AND RENEW DAMAGED THREADS ON STUB AXLES AND SPINDLES ON MOST VEHICLES!



792,68
590,00

3-PC 3/8" Spark Plug Rethread Kit

XX1810-SPRTLM203

- Serves all major vehicle platforms using 12, 14, and 16mm spark plugs
- Taps feature a 5/8" hex head, and 3/8" square drive



646,76
490,00

3-PC Thread Restorer File Set

XX1810-TFTFM932A

- Includes 3 commonly needed files
- Files service a range of 9-32 threads per inch & 0.75mm 3mm pitches



326,04
250,00

LENGTH ELIMINATES THE NEED FOR EXTENSIONS, REDUCING THE CHANCE OF CROSS-THREADING!

BLUE-POINT ESSENTIALS!

548,72
380,00

NEW PRODUCT!

5-PC Pivot Head Torx Wrench Set

XX1810-BLPPKTX5

- Set includes sizes T30 - T50



5-PC Pivot Head Hex Wrench Set

XX1810-BLPPKM5

- Set includes sizes 4-8mm

548,72
380,00



PIVOT HEAD ALLOWS USER TO INSERT WRENCH INTO A SOCKET HEAD SCREW WHILE PIVOTING AROUND OBSTACLES!

87-PC Torx & Hex Bit Socket Set

XX1810-BLPTH87

- Set includes a range of Torx®, External Torx®, Long Torx®, Metric Hex bit, Imperial Hex bit & Long Hex bit sockets



CONTAINS 1/4", 3/8" & 1/2" DRIVE SIZES!

2.470,38
1.400,00

5-PC Lambda Sensor Set

XX1810-ITC4993A

- Set includes sockets for a 22mm Lambda sensor - including M18 x 1.5 thread chaser
- Manufactured from chrome molybdenum (Cr-Mo) for superior corrosion resistance and strength to weight ratio



627,00
420,00

BACK BY POPULAR DEMAND!

GET A GREAT DEAL!

These great multi-purpose service sets feature a range of essential tools including:

- Sockets
- Breaker bars
- Ratchets
- Extensions

...AND MORE!



37-PC 3/8" General Service Set
XX1810-BLPGSS3837

- Set contains a ratchet, a range of sockets, wrenches, extensions and much more!

1.434,50
890,00

★
3/8"
★



77-PC 3/8" Service Set
XX1810-277MBPGSSUK

1.954,34
1.090,00

★
1/4"
★



47-PC 1/4" Service Set
XX1810-147MBPGSSUK

685,90
490,00

★
1/2"
★



33-PC 1/2" General Service Set
XX1810-BLPGSS1233

1.887,08
1.290,00

'OUTSANDING' TOOLS!



6" Orbital Finishing Sander

XX1810-PSF4612VHCWNKIT

- Ergonomic S-curved lever fits hand for optimum comfort
- Max free speed: 12,000 RPM
- Adjustable free speed for greater control

2.719,28
1.490,00

GREAT QUALITY AND PERFORMANCE!



6" Orbital Palm Sander

XX1810-AT406C

- Built-in power regulator for optimised power control
- 12,000 RPM free speed for 'swirl-free' finishes

WELL-BALANCED FOR SMOOTH HANDLING!

1.163,18
820,00

DON'T FORGET YOUR AIR HOSE!

10M Air Hose

XX1810-AIRHOSE35

573,04
390,00

- 13,7bar working pressure
- Reinforced construction eliminates layer separation



MECHANIC'S ESSENTIALS!

BUY THIS

3-PC Straight Tip Pry Bar Set

XX1810-MPBS703APBHCKIT

- Includes 12", 24" and 36" pry bars
- Blade extends through handle and contacts the metal end cap to provide a continuous, solid striking force

2.415,66
1.500,00

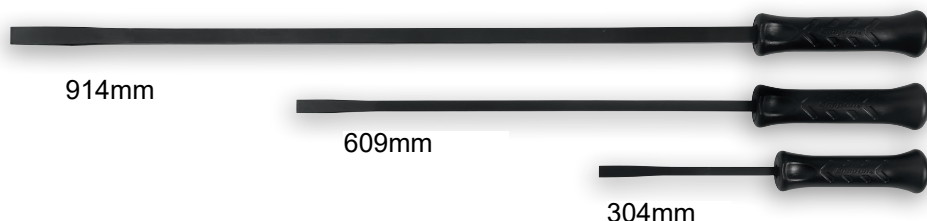

GET THIS FREE!

1219 mm Heavy Duty Wrecking Bar

LONG LENGTH FOR GREATER LEVERAGE!

- Rubber grip eliminates contact with rust and damaged surfaces
- Grip offers non-slip surface that provides secure gripping when hands are wet or oily



Air-mazing

3/8" Air Impact Wrench

XX1810-MG325/G/HV
XX1810-MG325/G/HV
XX1810-MG325/G/HV

- Patented tip valve trigger provides increased air flow and greater tool control
- Anvil stop feature - prevents anvil from throwing nuts and sockets

i

SPECIFICATION

Torque Output (Nm)	Up to 440
Blows Per Minute (BPM)	1,400
Free Speed (RPM)	10,700
Air Consumption (CFM)	4

3-136,14
1.990,00



Snap-on Air Saw

XX1810-PTS1000

- 3mm (1/8") mild steel cutting capacity
- Featherable paddle trigger with safety lever
- 10,000 RPM free speed

2-237,44
1.550,00



NEW!

1/4" Keyless Chuck Micro Reversible Air Drill

XX1810-PDR2501

- Keyless chuck for quick and easy bit change
- One-handed forward/reverse for easy operation
- Excellent runout for consistent drilling, reaming and honing

GREAT FOR DRILLING SHEET METAL AND DRILLING OUT RIVETS AND SCREWS!

2-449,86
1.550,00



3" Cut Off Tool

XX1810-PT250A

- Ergonomic cushion handle
- Adjustable rear exhaust diverts exhaust away from the work area
- Built-in 10 position power/speed regulator allows you to match speed to job requirement quickly and easily



i

SPECIFICATION

Sound Level (dBA)	86.1
Free Speed (RPM)	22,000
Air Consumption (CFM)	3.2

1-784,48
1.090,00

POWER TOOLS!

1/2" Air Impact Wrench with Vinyl Boot

XX1810-AT5500

- Built-in five position adjustable air regulator plus a variable speed trigger for maximum user control



INCLUDES FREE VINYL BOOT!

1-928,50
1.100,00

i

SPECIFICATION

Torque Output (Nm)	Up to 745
Blows Per Minute (BPM)	1,200
Free Speed (RPM)	7,400
Air Consumption (CFM)	4.2



Ask about motor oil for your air tools!
XX1810-IM1PTMP6

Pack of 6 bottles **473 ml**

507,68
350,00

BUY THIS



3/8" Air Ratchet

XX1810-AT206-204KIT

3.005,42
1.450,00

- 150 RPM for fast removal and installation of fasteners
- Average CFM 1.4
- Working torque 10 – 240 in.lbs

PRECISION PLANETARY GEAR SYSTEM FOR SMOOTH PERFORMANCE!

GET THIS FREE!

1/4" Mini Air Ratchet

- Easy to use variable speed throttle
- Head boot included which keeps debris out of tool

COMPACT SIZE ALLOWS GREATER ACCESS TO TIGHT SPACES!



POWERFUL BUY & GETS!

BUY THIS

1/2" Air Impact Wrench

XX1810-PT850SIMMKIT
 XX1810-PT850GSIMMKIT
 XX1810-PT850HVSIMMKIT
 XX1810-PT850OSIMMKIT

- Optimised power to weight ratio for maximum power and user comfort
- 1,098Nm of maximum torque, delivered from featherable trigger
- Reduced weight of just 1.9kgs - less fatigue

BIG POWER WITH PRECISE CONTROL!



5.901,78
3.800,00



SPECIFICATION	
Torque Output (Nm)	Up to 1,098
Blows Per Minute (BPM)	1,270
Free Speed (RPM)	9,200
Air Consumption (CFM)	4.1

GET THIS FREE!

10-PC 1/2" Deep Impact 6pt Socket Set



CONTAINS SIZES 10-19MM

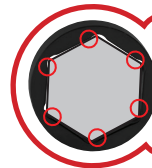

FLANK DRIVE®

Socket drives fasteners on the flats, therefore providing 15-20% more turning power and less chance of rounding

CONVENIENT ADDITIONS TO YOUR KIT!

UV LED Light

XX1810-COAPX100

- Impact and weather resistant
- Ideal for detecting oil leaks, air conditioning and general leaks



259,54
190,00

6-PC 1/4" Hex Socket Set

XX1810-106ETMAMY



CONTAINS SIZES 2-6MM

916,18
520,00

7-PC 1/4" General Service Set

XX1810-107ATMPB

- Set includes: ratchet, shank driver, 3-PC extension set, breaker bar and universal joint



1.983,22
1.100,00

1/4" Standard Handle Industrial Ratchet

XX1810-GT72



DUAL 80
 TECHNOLOGY

576,46
320,00

HALF PRICE!

THE ULTIMATE FLOOR JACK!

2 Tonne Snap-on Floor Jack

XX1810-FJ200EUR

3916,66
3.000,00

ASK ME FOR MY BEST DEAL!

AMAZING DURABILITY, PERFORMANCE & RELIABILITY!

Low entry height of 89mm
gets under majority of vehicles

Grease fittings on front wheels & handle yoke
for easy maintenance

Dual-pump pistons
reach service height quickly

Maximum lift height of 584mm
great versatility

Internal filtration
maintains oil cleanliness and performance

Premium U-Cup seals
ensure long life



TORQUE OF THE TOWN!

1/4" Flex-Head TechAngle® Torque Wrench

XX1810-ATECH1F240VR
XX1810-ATECH1F240VG
XX1810-ATECH1F240VO
XX1810-ATECH1F240VH

3.424,56
2.400,00

MEETS HIGHEST TECHNICAL SPECIFICATION STANDARDS!

ASK ME FOR A DEMO!

Dual 80® Technology
Provides superior torque with minimum swing arc



Large Backlit LCD Display
Makes viewing easier in tight quarters and at odd angles

Comfort Grip
Over-moulded non-slip handle with flared end provides secure grip, even in high-leverage applications

TIGHTEN WITH TORQUE & ANGLE!

Fully Programmable
Quickly change units of measure appropriate for specific application

Torque Range
1.36 - 27Nm

Flex-Head
Gets you into tight areas

Four Torque Alerts
Confirm proper torque and angle via LCD display, Dual Progressive LEDs, audio alert and vibration

CHOOSE YOUR COLOUR!



GREAT FOR ROCKER BOLTS ON A RANGE OF VEHICLES, BRAKE SYSTEMS, MOTORCYCLE ENGINE CASE AND CALIPER BOLTS, AND MUCH MORE!

HANDY TOOLS!

8-PC Soft Grip T-Handle Hex Key Wrench Set

XX1810-AWSGM800

- Contains sizes 2, 2.5, 3, 4, 5, 6, 8 and 10mm



672,60
470,00

8-PC Soft Grip Torx® T-Handle Wrench Set

XX1810-AWSGT800

- Contains sizes T10, T15, T20, T25, T27, T30, T40 and T45



684,38
490,00

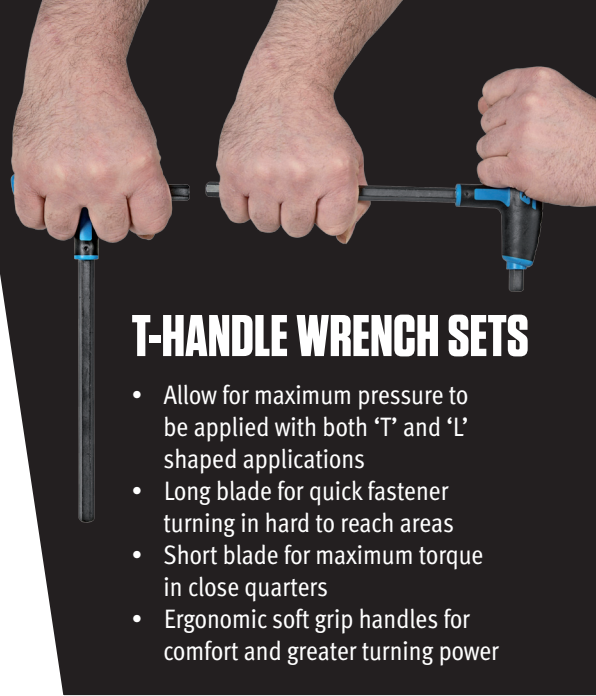

T-HANDLE WRENCH SETS

- Allow for maximum pressure to be applied with both 'T' and 'L' shaped applications
- Long blade for quick fastener turning in hard to reach areas
- Short blade for maximum torque in close quarters
- Ergonomic soft grip handles for comfort and greater turning power

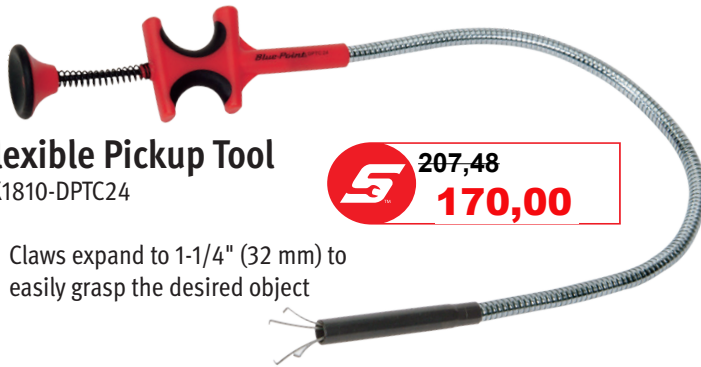

Flexible Pickup Tool

XX1810-DPTC24

207,48
170,00

- Claws expand to 1-1/4" (32 mm) to easily grasp the desired object

609MM FLEXIBLE SHAFT EASILY MANOEUVRES THROUGH TIGHT SPOTS!

10-PC Soft Grip Terminal Tool Set

XX1810-SGTT110

826,88
550,00

- Easily removes terminals from electrical connectors

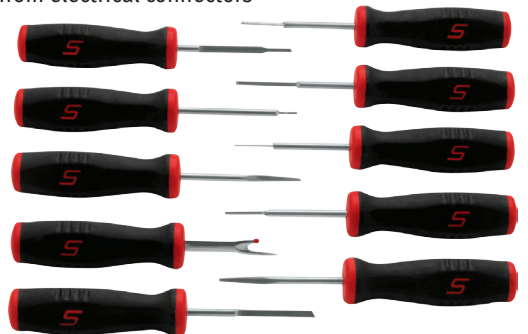

12-PC Panel Popper Set

XX1810-ITCPPS12-S

- Set includes 12 different sizes and styles that allow easy removal of door panels, trim fasteners and mouldings, inside and outside the vehicle

GREAT FOR INTRICATE BODY WORK!

760,76
390,00



18V Lithium LED Worklight

XX1810-CTLED8850

- Dual reflector system - beam or flood light
- 120° rotating head for versatility
- Dual brightness settings - 500 & 250 lumens

*Battery not included

12 HOUR MINIMUM RUN TIME!

670,70
520,00

Cordfree 12/24V DC Pocket Circuit Tester

XX1810-EECT200

399,76
250,00

- Use on autos and trucks from 3-24V DC
- Black carbon infused contact area completes circuit
- Buzzer LED light alerts user to DC voltage presence



Snap-on®

NOTHING EVEN COMES CLOSE!

10-PC Dual 80® Ratcheting Combination Wrench Set
XX1810-SOXRRM710

3.427,98
2.200,00

LOW PROFILE, THIN
WALLED HEADS FOR
OPTIMUM ACCESS!

DUAL 80

FLANK DRIVE® PLUS

**DUAL 80® RATCHETING
END PROVIDES GREAT
TURNING STRENGTH IN THE
TIGHTEST OF QUARTERS!**



7-PC 4-Way Open End Wrench Set
XX1810-VSM807B

1.866,56
1.100,00



**FOUR TURNING POSITIONS
- GREAT FOR AWKWARD
SPACES!**

**10-PC 12pt Combination
Wrench Set**
XX1810-SOEXM710

2.628,46
1.450,00



YOUR SNAP-ON DISTRIBUTOR

7-PC Short Ratcheting Wrench Set
XX1810-OXIRM707

- Up to 80 gear teeth with less than 5° ratcheting arc

1.331,52
990,00



ESSENTIAL WORKWEAR!

ALSO ARRIVING IN OCTOBER! ASK FOR MORE DETAILS!



Snap-on
Thinsulate Gloves
LOGOGLVPK10



Bobble Hat
LESBOBBLEHAT



Heavy Duty Winter Jacket
LOGOHDWJ-M/L/XL/XXL



Performance Overalls
LOGOOVL4-M/L/XL/XXL



Synergy Jacket
CHKJ3750M/L/XL/XXL



Heavy Duty Fleece
LOGOHWFLC-M/L/XL/XXL



Heavy Duty Body Warmer
LOGOHDBW-M/L/XL/XXL

STORAGE SOLUTIONS!

Heritage Folding Shelf

- For Heritage series roll cabs and KRSC430/46 carts*

KRA412GPJJ

1.500,00
1.200,00

PICK YOUR COLOUR!



KRA412GPB0



KRA412GPCM



KRA412GPC



4 Drawer Tool Chest
KRW184B

- Four lockable storage drawers
- Hinged lid with extra storage
- Measures W20" x D8.5" x H14"

1.235,30
990,00



3 Tier Roll Cart
ITCSTC111S

- 300lb weight capacity

1.550,00
1.250,00



Snap On EEBCBENCH-EU punjač cijena u akciji 990 kn + pdv

KARAKTERISTIKE :

- Stanje akumulatora prikaz u postotcima
- Punjač akumulatora sa 3 programa punjenja
- BRZO - 15 ampera
- SPORO - 10 ampera
- ODRŽAVANJE - 2 ampera
- Za baterije 12 i 6V
- Za sve tipove baterija na tržištu
- Kompiutersko upravljanje punjenjem
- Jamstvo 12 mjeseci



Snap On EEJP600E starter / booster cijena u akciji 2590 kn + pdv

TEHNIČKE KARAKTERISTIKE :

- Struja pokretanja 350A
- Hladan start struja pokretanja 290 A
- AGM baterija unutarna
- Zaštita krivog polariteta
- Digitalni pokazivač napunjenosti interne baterije , napona DC, i napunjenosti baterije vozila kada se spoji
- USB Port – 5 V DC 2 A za punjenje mobitela i ostalih USB uređaja
- Specijalna tehnologija provjerava stanje akumulatora prije startanja i ako je napon u akumulatoru manji od 1.5V
- Kablovi za pokretanje dužine 1.5 metara
- Specijalni nosači kliješta za uklanjanje oksida sa kliješta - PATENT SNAP ON
- 4 A punjač akumulatora integriran za produženje trajanja unutarnje baterije
- Odvojen prekidač ON - OFF
- Punjenje baterije sa 220V



Snap On EEBCBENCH-EU punjač cijena u akciji 2990 kn + pdv



TEHNIČKE KARAKTERISTIKE

- Kompletan uređaj je izrađen od karbonskih vlakana
- Test akumulatora za osobna vozila, kamione, motocikle, ATV, itd...
- Horizontalno položen uređaj sa specijalnim kućištem od gume za ublažavanje udaraca i protiv izkliznuća iz ruke
- Pozadinsko osvjetljenje LCD ekrana
- Izbornik sa 8 svjetskih jezika
- Zaštita strujna u slučaju promjene polariteta na kliještima mjernim
- Testiranje 6, 8 i 12V baterije
- Testiranje akumulatora od 100-1700 CCA
- Testiranje svih standardnih akumulatora AGM, GEL i EFB
- Podržani standardi CCA, CA, SAE, EN, IEC, DIN, JIS
- SNAP ON patentirana tehnologija provjere akumulatora
- Mogućnost provjere ispražnjenog akumulatora sve do 1V
- Testiranje alternatora i kompletnog sustava punjenja
- Napajanje sa vozila ili interne baterije od 9V
- Personalizirani PRINT sa informacijama servisa
- Magnet na kućištu za jednostavnu montažu uređaja na vozilu za vrijeme testiranja akumulatora ili punjenja
- Detekcija vanjske temperature zbog točnosti mjerenja
- Testiranje DIODA punjenja
- Detekcija neispravnog članka u akumulatoru
- 2 godine jamstvo